



DRT SERIES

SINGLE-PHASE FILTERS FOR INVERTERS

COMPONENTS

PART NO.	Cx1 (uF)	Cx2 (uF)	Cy (nF)	L (mH)	Lg (uH)	R (KΩ)
16DRT1W3A	1.0	0.68	4.7	1.7	32	200
*30DRT1W3	2.2	1.0	10	2.2	-	

*UL APPROVED

INTRODUCTIONS

1. Applications: Electric equipment, UPS, machine tool, copy machine, automation equipment, robot, AC motor drive
2. Voltage rating: 250VAC
3. Operating frequency: 50/60Hz

MINIMUM INSERTION LOSS IN dB

PART NO.	COMMON MODE (L-G) IN 50 OHM SYSTEM								
	FREQUENCY-MHz								
	.01	.05	.10	.15	.50	1.0	5.0	10	30
16DRT1W3A	5	5	20	30	60	65	65	65	55
30DRT1W3	5	10	20	25	40	45	50	50	35

PART NO.	DIFFERENTIAL MODE (L-L) IN 50 OHM SYSTEM								
	FREQUENCY-MHz								
	.01	.05	.10	.15	.50	1.0	5.0	10	30
16DRT1W3A	2	10	10	25	55	60	60	60	60
30DRT1W3	5	10	35	40	60	60	50	50	35

ELECTRICAL SCHEMATIC

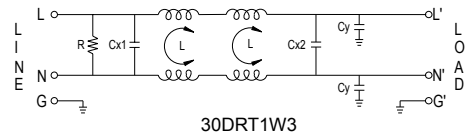
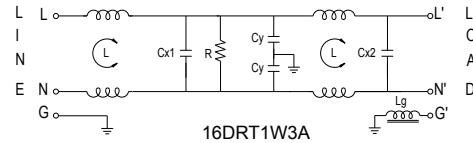

SERIES DIMENSIONS

PART NO.	DIMENSIONS IN INCHES/mm							
	A	B	C	D	E	F	G	H
16DRT1W3A	8.740	5.197	1.654	7.795	3.937	9.843	7.795	0.787
	222.0	132.0	42.0	198.0	100.0	250.0	198.0	20.0
30DRT1W3	10.906	7.956	2.047	9.961	6.693	7.874	9.961	0.984
	277.0	202.0	52.0	253.0	170.0	200.0	253.0	25.0

INSERTION LOSS (TYPICAL)

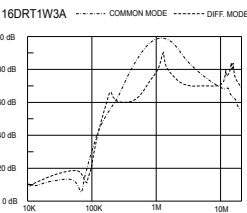
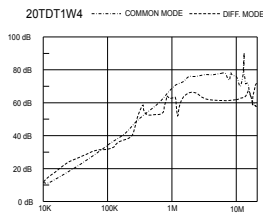
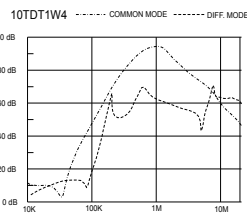
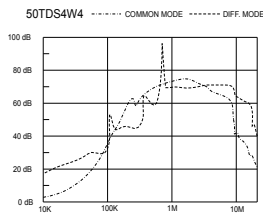

MECHANICAL CONSTRUCTION

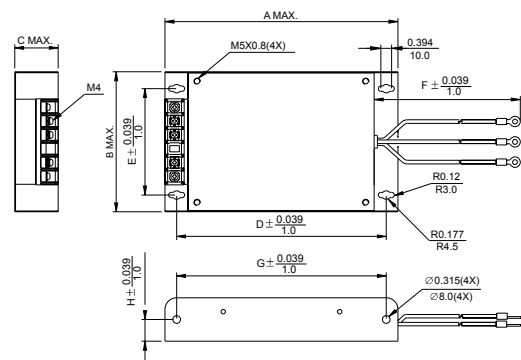

UNIT: INCH
mm

THREE-PHASE FILTERS