

Product specification for inductive components

Type: SC14905-R



www.epa.de

Ansicht - Avis - View



EPA Artikel-No.	5S031132
Core finishing	Cased
Additional Information	Differential Mode Choke

Abmessungen - Dimensions - Dimensions (mm)

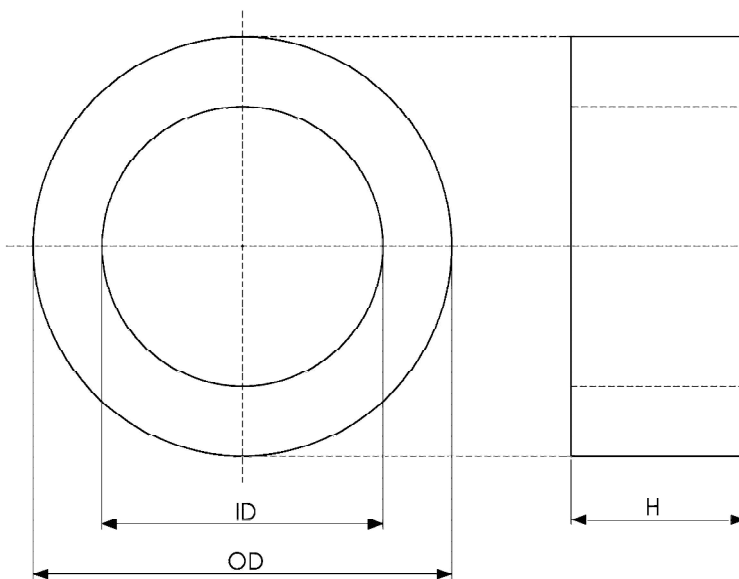

OD	≤ 43.1
ID	≥ 28.8
H	≤ 17.4

SO 4.2.2-02 Rev.4