

Product specification for inductive components



Type: SC10575-R

www.epa.de

Ansicht - Avis - View



EPA Artikel-No.	5S030783
Core finishing	Cased
Additional Information	Common Mode Choke

Abmessungen - Dimensions - Dimensions (mm)

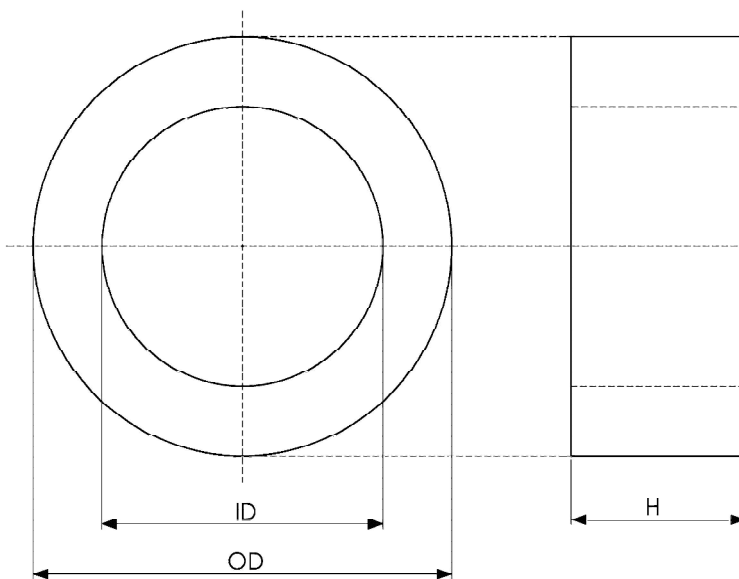

OD	≤ 135
ID	≥ 94
H	≤ 34

SO 4.2.2-02 Rev.4